

Panasonic[®]

Portable Stereo Component System RX-DS515

Operating Instructions



Before connecting, operating or adjusting this product, please read these instructions completely.

COMPACT
disc
DIGITAL AUDIO

Precautions

Installation

Environment

- 1. Water and Moisture**—Do not use this unit near water—for example, near a bathtub, washbowl, swimming pool, or the like. Damp basements should also be avoided.
- 2. Condensation**—Moisture may form on the lens in the following conditions...
 - immediately after a heater has been turned on.
 - in a steamy or very humid room.
 - when the unit is suddenly moved from a cold environment to a warm one.If moisture forms inside this unit, it may not operate properly. To correct this problem, turn on the power and wait about one hour for the moisture to evaporate.
- 3. Heat**—The unit should be situated away from heat sources such as radiators and the like. It also should not be placed in temperatures less than 5°C (41°F) or greater than 35°C (95°F).

Placement

- 1. Ventilation**—The unit should be situated so that its location or position does not interfere with its proper ventilation. Allow 10 cm (4") clearance from the rear of the unit.
- 2. Foreign Material**—Care should be taken so that objects do not fall into and liquids are not spilled into the unit. Do not subject this unit to excessive smoke, dust, mechanical vibration, or shock.
- 3. Magnetism**—The unit should be situated away from equipment or devices that generate strong magnetic fields.
- 4. Stacking**—Do not place heavy objects, other than system components, on top of the unit.
- 5. Surface**—Place the unit on a flat, level surface.
- 6. Carts and Stands**—The unit should be used only with a cart or stand that is recommended by the manufacturer. The unit and cart combination should be moved with care. Quick stops, excessive force, and uneven surfaces may cause the unit and cart combination to overturn.
- 7. Wall or Ceiling Mounting**—The unit should not be mounted to a wall or ceiling, unless specified in this operating instructions.



Maintenance

Clean the cabinet, panel and controls with a soft cloth lightly moistened with mild detergent solution. Do not use any type of abrasive pad, scouring powder or solvent such as alcohol or benzene.

Service

- 1. Damage Requiring Service**—The unit should be serviced by qualified service personnel when:
 - (a) The AC power supply cord or the plug has been damaged; or
 - (b) Objects have fallen or liquid has been spilled into the unit; or
 - (c) The unit has been exposed to rain; or
 - (d) The unit does not appear to operate normally or exhibits a marked change in performance; or
 - (e) The unit has been dropped, or the enclosure damaged.
- 2. Servicing**—The user should not attempt to service the unit beyond that described in the operating instructions. All other servicing should be referred to an authorized service personnel.

(Only for U.S.A.)

Call 1-800-545-2672 for the address of an authorized factory servicenter.

Listening caution



Selecting fine audio equipment such as the unit you've just purchased is only the start of your musical enjoyment. Now it's time to consider how you can maximize the fun and excitement your equipment offers. This manufacturer and the Electronic Industries Association's Consumer Electronics Group want you to get the most out of your equipment by playing it at a safe level. One that lets the sound come through loud and clear without annoying blaring or distortion—and, most importantly, without affecting your sensitive hearing.

We recommend you to avoid prolonged exposure to excessive noise.

Sound can be deceiving. Over time your hearing "comfort level" adapts to higher volumes of sound. So what sounds "normal" can actually be loud and harmful to your hearing.

Guard against this by setting your equipment at a safe level **BEFORE** your hearing adapts.

To establish a safe level:

- Start your volume control at a low setting.
- Slowly increase the sound until you can hear it comfortably and clearly, and without distortion.

Once you have established a comfortable sound level:

- Set the dial and leave it there.

Taking a minute to do this now will help to prevent hearing damage or loss in future. After all, we want you listening for a lifetime.

THE FOLLOWING PHRASES ARE APPLIED ONLY FOR U.S.A.;

CAUTION:

This equipment has been tested and found to comply with the limits for a Class B digital device, pursuant to Part 15 of the FCC Rules.

These limits are designed to provide reasonable protection against harmful interference in a residential installation. This equipment generates, uses and can radiate radio frequency energy and, if not installed and used in accordance with the instructions, may cause harmful interference to radio communications. However, there is no guarantee that interference will not occur in a particular installation. If this equipment does cause harmful interference to radio or television reception, which can be determined by turning the equipment off and on, the user is encouraged to try to correct the interference by one of the following measures:

- Reorient or relocate the receiving antenna.
- Increase the separation between the equipment and receiver.
- Connect the equipment into an outlet on a circuit different from that to which the receiver is connected.
- Consult the dealer or an experienced radio/TV technician for help.

FCC Notice: This system complies with new Part 15, except for the radio receiver, which complies with old Part 15, Subpart C of the FCC Rules. Operation is subject to the following two conditions: (1) This device may not cause harmful interference, and (2) this device must accept any interference received, including interference that may cause undesirable operation. The radio receiver is not subject to above item (2).

Any unauthorized changes or modifications to this equipment would void the user's authority to operate this device.

Connections

Speaker system connection

This unit can be used as a one-piece portable stereo radio cassette recorder, or a three-piece component system, by attaching or detaching the speaker system.

Before attaching or detaching the speakers, be sure to disconnect the speaker cables from the speaker terminals. Be sure to set SELECTOR to TAPE/OFF to turn the unit off before connecting or disconnecting the speaker cables.

Attaching the speakers

Align the speaker with the main unit as shown in the figure, interlock the grooves and press down.

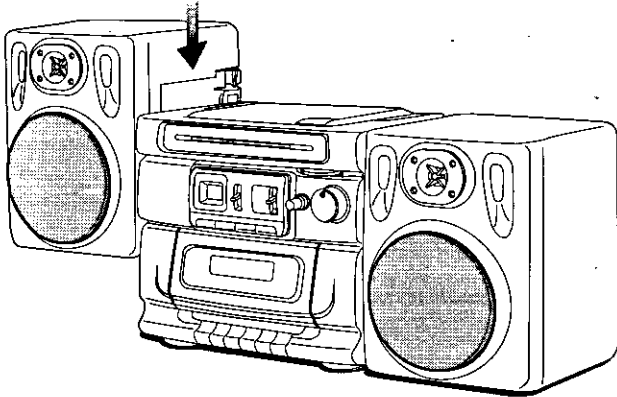

Connect the speaker cable (black) to the \ominus (negative) speaker terminal, and the other speaker cable (red) to the \oplus (positive) speaker terminal.

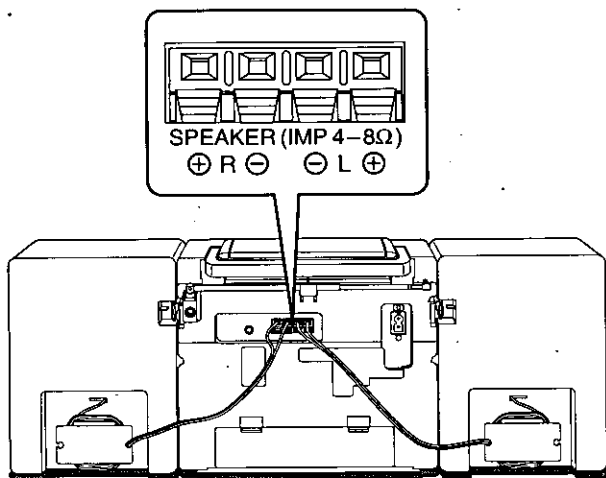

When using the unit with the speakers attached, wind the speaker cables as shown.

Note

Since a strong magnet is used for the speaker, keep magnetized commuter passes, tickets or personal credit cards, recorded tapes, watches, etc. away from the unit. The speaker magnet in the unit may damage them.

Detaching the speakers

Unlock the speaker release levers by pulling them in the direction shown below, and slide each speaker up.

Connect the speaker cables to the speaker terminals.

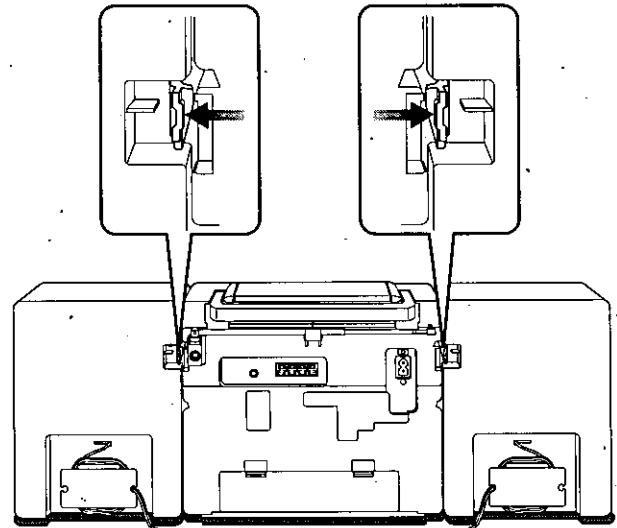

Power Sources

Supplied Accessory

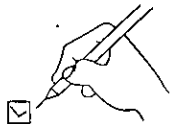

Please check and identify the supplied accessory.

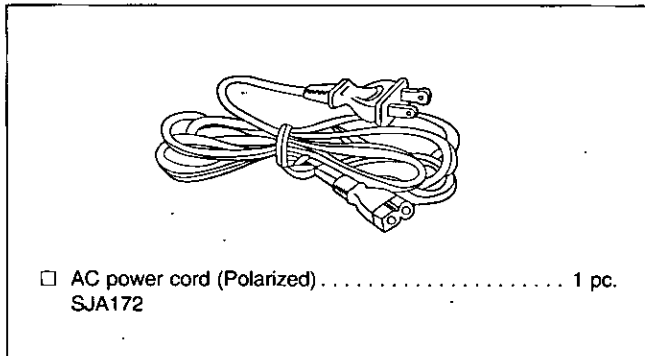

(Only for U.S.A.)

To order accessories call MSC Accessory Dept. 1-800-332-5368.

To operate AC power

Connect the included AC power cord to the AC socket of the unit and your household AC outlet.

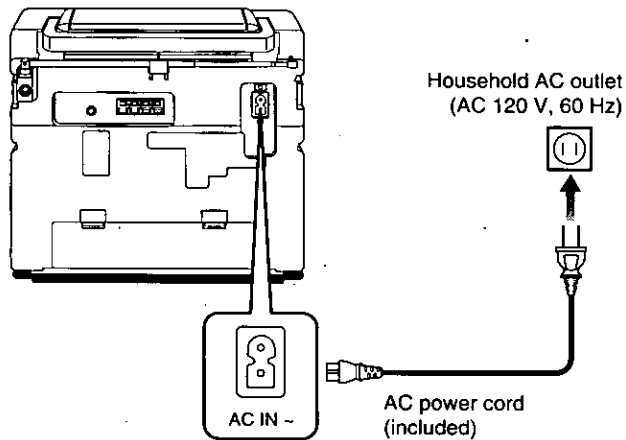

To operate on battery power

Battery installation

Unplug the AC power cord from the household AC outlet and the AC socket of the unit.

Insert six "D" size (R20/LR20 or equivalent, not included) batteries into the battery compartment, making sure that the batteries are installed in the designated numerical order and that the proper polarities are maintained.

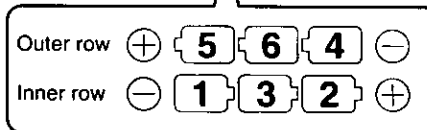
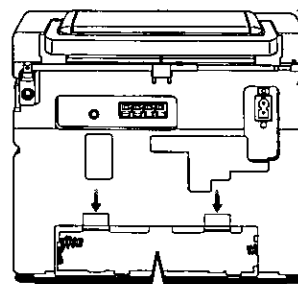

- Batteries installed with incorrect polarities may leak and damage this unit.
- Do not mix batteries (old and new) or types (manganese and alkaline, etc.).
- If the unit is not used for a long period of time or is used only from an AC power source, remove the batteries to prevent potential damage from possible battery leakage.

Battery removal

Remove as shown in the figure below.

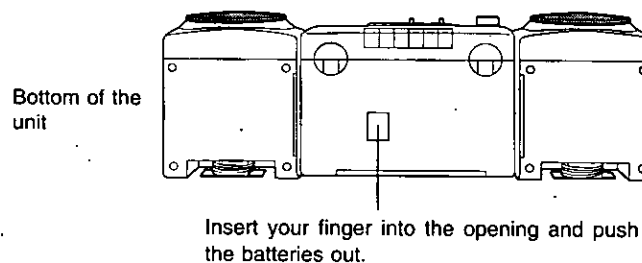

Battery life

When the batteries are weak, the tape speed will slow down, the sound will become distorted, and the volume will decrease. Replace all the batteries with new ones.

Common Operations

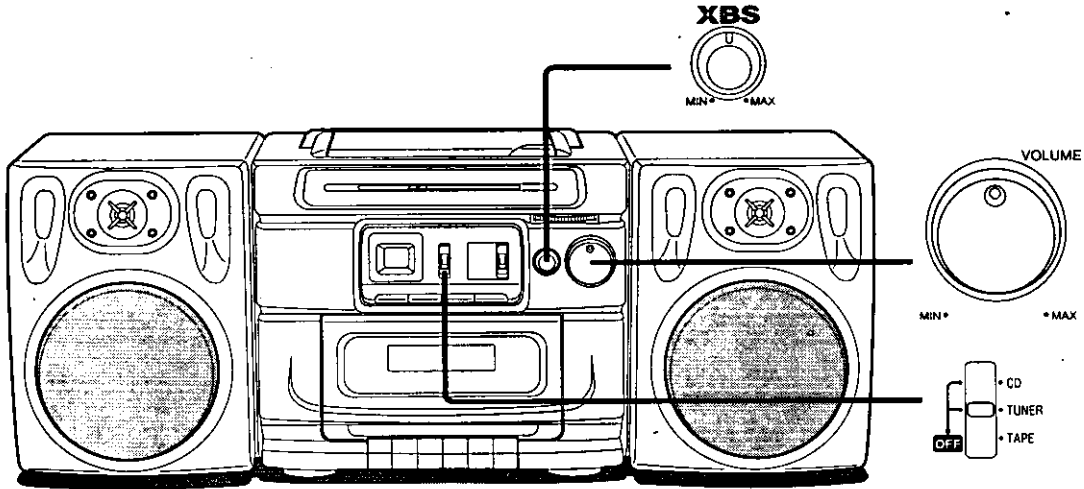

To listen to the radio

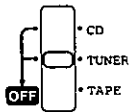

Set **SELECTOR** to "TUNER".

Adjusting the deep bass (XBS)



Turn **XBS LEVEL** to adjust the deep bass to the desired level.

To listen to CDs

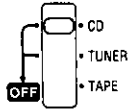

Set **SELECTOR** to "CD".

Listening through headphones (not included)

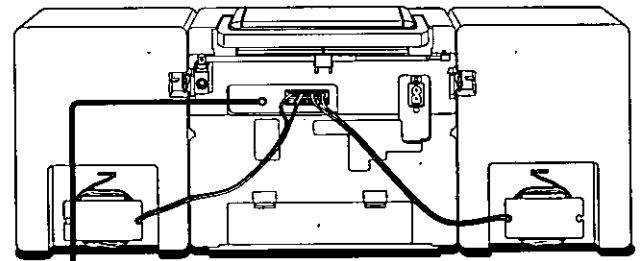

To listen to tapes

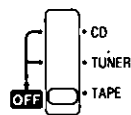

Set **SELECTOR** to "TAPE/ **OFF**".



Turn down the volume and connect the headphones to the **PHONES** jack.

Plug type: Stereo mini
Avoid listening for prolonged periods of time to prevent hearing damage.

Adjusting the Volume

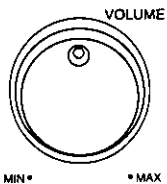

Turn **VOLUME** to adjust the volume to the desired level.

Turn it clockwise to turn up the volume. Turn it counter-clockwise to turn down the volume.



Turning the unit off

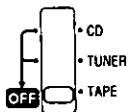

Set **SELECTOR** to "TAPE/ **OFF**".
Press **STOP/EJECT** if a tape is travelling.

Listening to the Radio

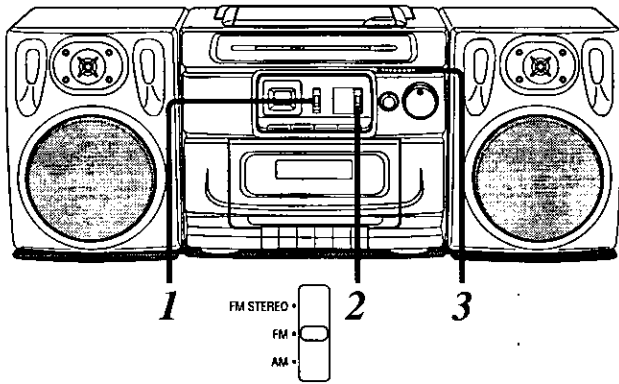

Selecting a radio station

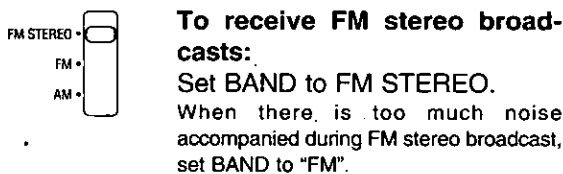
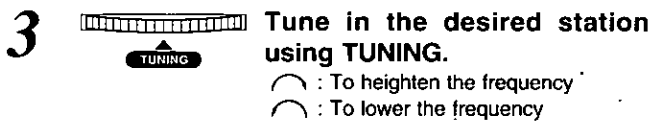
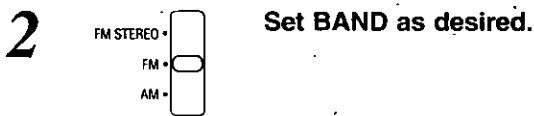
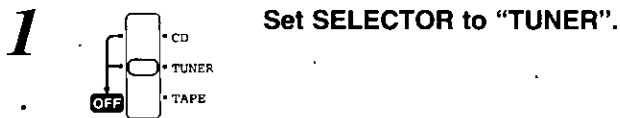

Adjusting the antenna

For FM reception:

Adjust the length and direction of the telescopic antenna.

For AM reception:

Adjust the direction in which the unit is pointed.

For your reference:

Radio broadcasts may be hard to receive in a building or moving vehicle because their signals are weak. Whenever possible, use the unit by a window.

Listening to the Tape

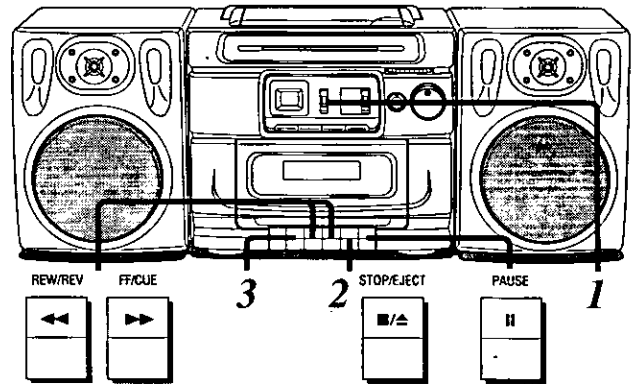

Only normal tapes (TYPE I) can be used.



To stop play:

Press STOP/EJECT.

To temporarily stop play:

Press PAUSE.

To resume play, press PAUSE again.

To rewind or fast forward the tape

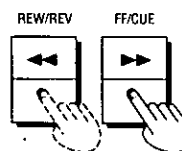

In the stop mode, press REW/REV or FF/CUE.

Do not press PLAY during rewinding or fast forwarding, as this may jam the tape. Be sure to press STOP/EJECT before proceeding to the next operation.

To search a particular spot on a tape

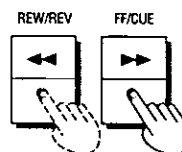

During playback, press REW/REV or FF/CUE.

Tape play is resumed when the button is released.

Type of tape which can be played on this unit:

Normal position/TYPE I	○
High position/TYPE II	×
Metal/TYPE IV	×

This unit will not be able to do full justice to characteristics of high-position tapes and metal tapes even if they are played back.

Listening to Compact Discs

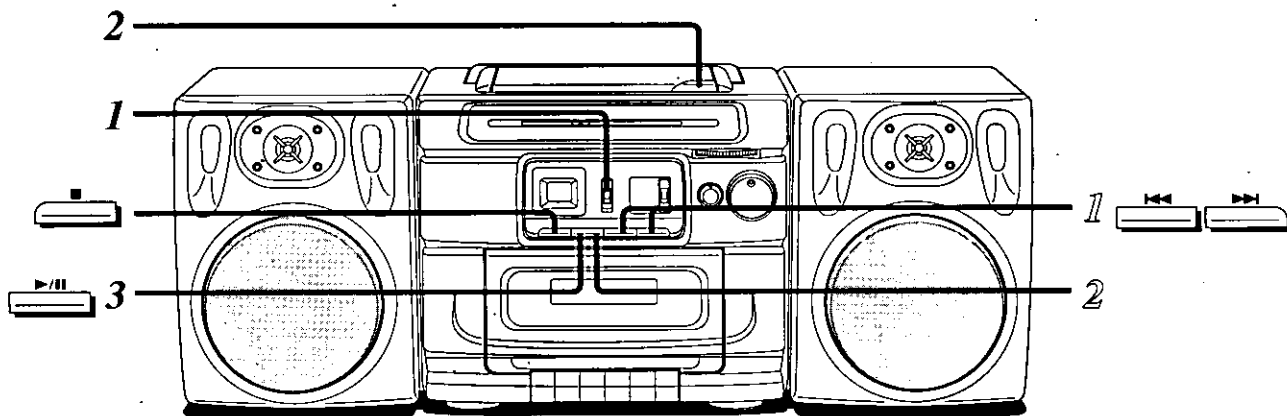

1 Set SELECTOR to "CD".

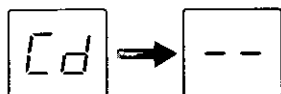
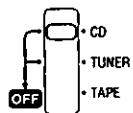

2 Press CD ▲, insert the CD with its label side facing up.

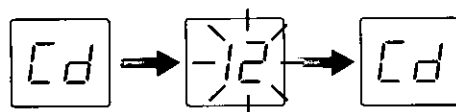
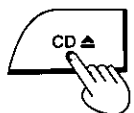

3 Press ►/|| to start play. Play starts from track 1 and continues to the last track, after which it automatically stops.

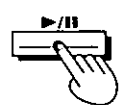

To stop play:



Press ■.

To stop play temporarily:



Press ►/||.

The number of the track which was previously playing will be flashing.

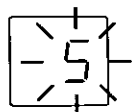

To resume play:

Press ►/||.

Starting play from a specific track (Direct play)

1 In the stop mode, press ◀◀ or ▶▶ to specify the desired track.

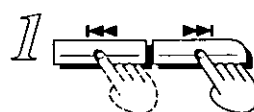

2 Press ►/|| to start play.

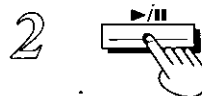

Skipping to the beginning of a track



In the play mode, press ◀◀ or ▶▶.

Press the same button repeatedly to skip tracks in the number that corresponds to the number of times you pressed the button.

Rapid forwarding and reversing (Search)

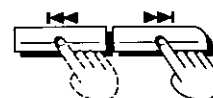

During play, keep pressing ◀◀ or ▶▶.

Release the button at the desired position.

Note

Interference may affect radio or TV reception when CDs are played close to a radio or TV set. If this occurs, place the unit as far away from the set as possible.

Recording Radio Broadcast

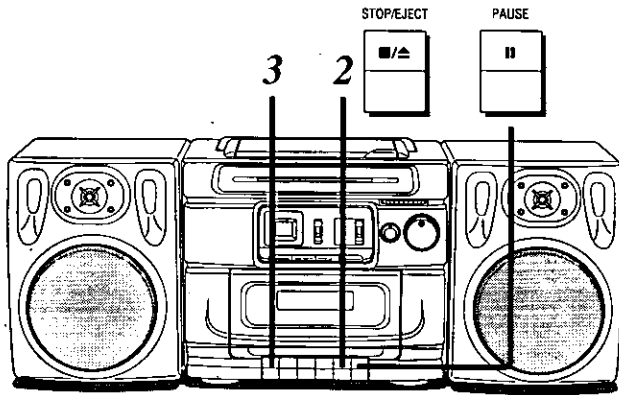

Only normal tapes (TYPE I) can be used.
Preparation: Take up the leader tape before proceeding.

- 1** **Tune in the broadcast station.**
(See page 7)
- 2** **Press STOP/EJECT and load the tape.**
Load the tape with the side to be recorded facing you.
- 3** **Press REC.**

To stop the recording:

Press STOP/EJECT.

To stop the recording temporarily:

Press PAUSE.

To resume recording, press PAUSE again.

Type of tape which can be used for recording:

Normal position/TYPE I	○
High position/TYPE II	×
Metal/TYPE IV	×

The sound may not be recorded properly if high-position tapes and metal tapes are used with this unit.

To take up the leader tape:

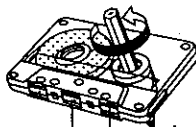

Magnetic part of tape
(Recording can be made.)

Leader tape
(Recording cannot be made.)

To erase sound previously recorded on a tape:

Recording new sound onto a pre-recorded tape automatically erases what was previously recorded.

To erase all the sound on a tape:

1. Load the tape with the side whose recording is to be erased facing you.
2. Set SELECTOR to TAPE/**OFF**.
3. Press REC.

Recording Compact Discs

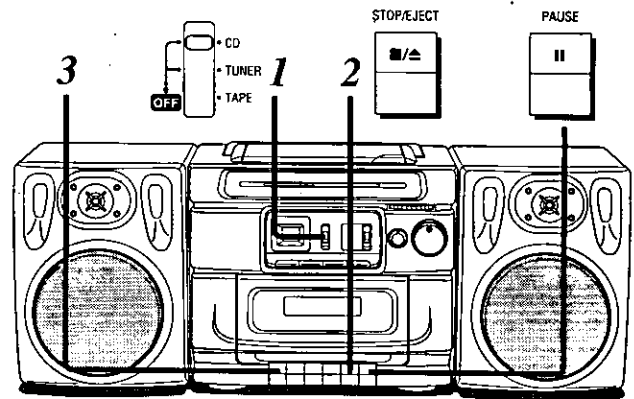

Preparation: Insert the CD.
Take up the leader tape before proceeding.

- 1** **Set SELECTOR to "CD".**
- 2** **Press STOP/EJECT and load the tape.**
 - Load the tape with the side to be recorded facing you.
 - Either have the leader tape wound up in advance or locate the position where recording is to begin. (See left).
- 3** **Press REC to start recording on the tape.**
CD play starts simultaneously.

To stop the recording:

Press STOP/EJECT.

To temporarily stop the recording:

Press PAUSE.

To resume recording, press PAUSE again.

For your reference:

- Any change made to the volume or XBS level during recording will not affect the recording.
- In order to prevent trouble caused by flat batteries, it is recommended that you either supply power to the unit from the household AC outlet or replace all the batteries with new ones when you are recording something which is important to you.

Concerning Compact Discs

Only compact discs having this mark can be used with this unit.



To remove a disc from its case

Press the center holder and lift the disc holding by the edges.

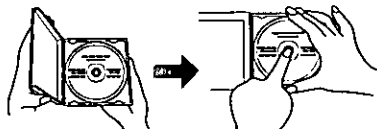

To hold the disc

Hold the disc by the edges so the surface is not soiled with fingerprints. Fingerprints, dirt and scratches can cause skipping and distortion.

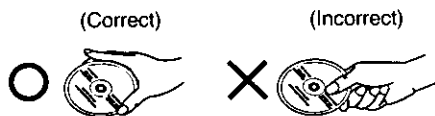

To store a disc in its case

Insert the disc with label facing upwards and press downward at the center.

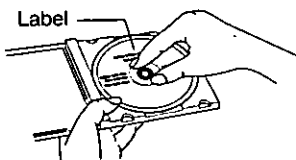

If the surface is soiled

Wipe gently with a soft, damp (water only) cloth.

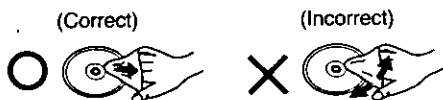

If the disc is brought from a cold to a warm environment, moisture may form on the disc

Wipe this moisture off with a soft, dry, lint-free cloth before using the disc.

Improper disc storage:

You can damage discs if you store them in the following places;

- Areas exposed to direct sunlight.
- Humid or dusty areas.
- Areas directly exposed to a heat outlet or heating appliance.

Handling precautions:

- Do not write on the label side with a ball-point pen or other writing utensils.
- Do not use record cleaning sprays, benzine, thinner, static electricity prevention liquids or any other solvent.
- Do not soil with fingerprints.

Concerning Cassette Tapes

Selection of cassette tapes

Only normal tapes can be used with this unit.

Cassette tape exceeding 100 minutes:

These tapes are handy for their long playback and recording time but be careful about repeatedly stopping and starting, rewinding and fast forwarding these tapes in short intervals as they are thin, tend to stretch and may become entangled in the deck mechanism.

Endless tapes:

Failure to operate these tapes correctly may cause the tape to wind around the revolving parts.

If the tape loosens, take up the slack

Tape slack may cause the tape to break.

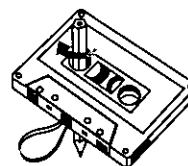

To prevent erasure of recorded sounds

Remove the erase-prevention tabs with a screwdriver or a similar object.

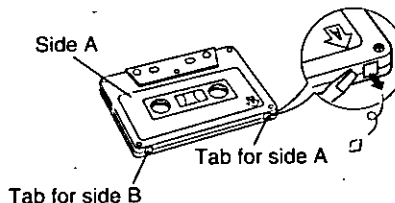

To re-record on a protected cassette, cover the slot with adhesive tape.

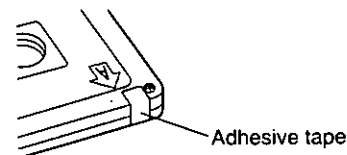

Improper tape storage:

You can damage tapes if you store them in the following places;

- In high temperature (35°C (95°F) or higher) or high humidity (80% or higher) areas.
- In a strong magnetic field (near a speaker, on top of a TV, etc.) This can erase a recording.
- Areas exposed to direct sunlight.

Troubleshooting Guide

Before requesting service for this unit, check the chart below for a possible cause of the problem you are experiencing. Some simple checks or a minor adjustment on your part may eliminate the problem and restore proper operation.

If you are in doubt about some of the check points, or if the remedies indicated in the chart do not solve the problem, refer to the directory of Authorized Service Centers (enclosed with this unit) to locate a convenient service center, or consult your dealer for instructions. (In U.S.A. consult MSC Authorized Servicenters for detailed instructions or call 1-800-545-2672 for the address of an authorized factory servicenter.)

Problem	Probable cause(s)	Suggested Remedy	Page
---------	-------------------	------------------	------

Common problems

No operation when unit is powered by batteries.	Is the AC power cord still connected to the unit while batteries are being used?	Disconnect the AC power cord.	5
	Are the batteries flat?	Replace them with new ones. Alternatively, use a household AC outlet as the power source.	5
	Have the batteries been installed incorrectly with their (+) and (-) polarities reversed?	Align the (+) and (-) polarities correctly.	5

While listening to CDs

Play does not start. No display of track numbers, etc.	Has the CD been installed upside down?	Install the CD with the label side facing up.	8
	Has condensation formed on the unit's CD section?	Turn the unit on and leave it on for about an hour before further operation.	/
Certain sections are not played properly.	Is the CD dirty?	Wipe it with a soft cloth.	10
	Is the CD scratched?	Replace it with a new CD.	10

While listening to tapes

Tape is not ejected.	Are the batteries flat?	Replace them with new ones or, alternatively, use a household AC outlet as the power source and then perform the operation once again.	5
No recording.	Have the erase-prevention tabs been removed?	Cover the holes with adhesive tape.	10
High level of noise; poor sound quality.	Are the heads dirty?	Clean them.	12
	Have the heads been magnetized?	Demagnetize them using a head eraser available from an audio store.	12

While listening to the radio

High level of noise; stations cannot be tuned in well.	Has the antenna been adjusted properly?	Try changing its direction.	7
Noise heard during AM reception.	Are you operating the unit and a TV set at the same time?	Place the unit at a distance from the TV. Alternatively, turn off the TV's power.	/
	Are you using a remote controller of other appliances near the unit?	Use the remote controller at a distance.	/

Product Service

Do not attempt to remove the cover(s) or repair the unit yourself. Refer servicing to qualified personnel only.

Product information

For product service, product information or assistance with product operation, refer to the servicenter directory.

Maintenance

Maintenance of external surfaces

To clean this unit, use a soft, dry cloth.

If the surfaces are extremely dirty, use a soft cloth dipped in a soap-and-water solution or a weak detergent solution.

Wring the cloth well before wiping the unit.

Wipe once again with a soft, dry cloth.

Never use alcohol, paint thinner, benzene, or chemically treated cloths to clean this unit. Such chemicals may damage the finish of your unit.

Tape head care

To assure sound quality for recording and playback, be sure to clean the tape heads after approximately every 10 hours of use.

1. Open the cassette deck holder cover by pressing STOP/EJECT.
2. Clean the tape heads, pinch roller and the capstan shaft with a cotton swab (or a soft, lint-free cloth) slightly moistened with isopropyl alcohol.

Do not use any solution other than alcohol for head cleaning.

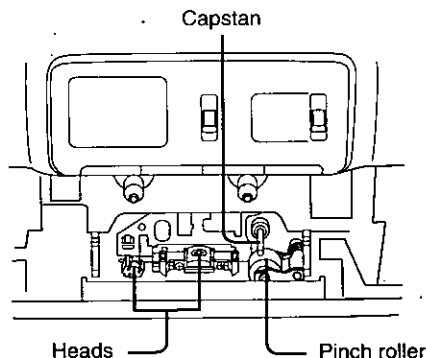

It is recommended that the head assembly be demagnetized if distortion or poor sound quality persists after cleaning the heads. Demagnetize them using a demagnetizer available from an audio store.

Lens care

Open the disc lid and clean the lens with a blower (not included). If the lens is extremely dirty, clean it with a cotton swab.

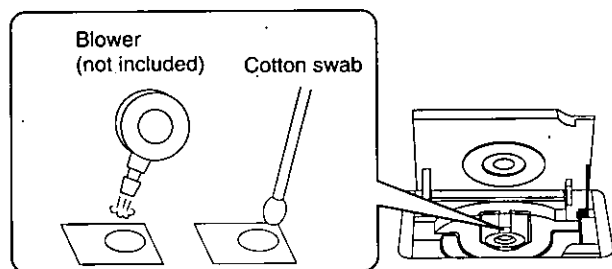

Matsushita Consumer Electronics Company, Division of Matsushita Electric Corporation of America
One Panasonic Way Secaucus,
New Jersey 07094

Panasonic Sales Company, Division of Matsushita Electric of Puerto Rico, Inc. ("PSC")
Ave. 65 de Infanteria, Km. 9.5
San Gabriel Industrial Park, Carolina,
Puerto Rico 00985

Matsushita Electric of Canada Limited
5770 Ambler Drive, Mississauga,
Ontario
L4W 2T3

Technical Specifications

Radio

Frequency range

FM

88-108 MHz

AM

525-1705 kHz

CD player

Sampling frequency

44.1 kHz

Decoding

16 bit linear

Beam source

Semiconductor laser (wavelength 780 nm)

No. of channels

2 channel, stereo

Frequency response

20 Hz-20 kHz (+0, -2 dB)

S/N ratio

70 dB

Wow and Flutter

Less than possible measurement data

D/A converter

MASH (1 bit DAC)

Tape recorder

Track system

4 track, 2 channel, stereo

Recording system

AC bias

Erasing system

Magnet

Monitor system

Variable sound monitor

Frequency range

Normal

50-14,000 Hz

General

Power requirement

AC

120V, 60Hz

Battery

Power consumption: 16 W

9 V (Six "D" size, R20/LR20 batteries)

Speakers

2 Woofer; 12 cm (4³/₄")

2 Tweeter; 1.5 cm (9/₁₆")

Jacks

Output

Speaker; 4-8 Ω

Headphones; 32 Ω

Dimensions (WxHxD)

585 x 228 x 215 mm

(23¹/₁₆" x 9" x 8¹/₂")

Main unit; 265 x 228 x 215 mm

(10⁷/₁₆" x 9" x 8¹/₂")

Speaker box; 170 x 224 x 203 mm

(6¹/₁₆" x 8¹³/₁₆" x 8")

Weight

4.5 kg (9 lb. 15 oz.) without batteries

Note:

Specifications are subject to change without notice.

Weight and dimensions are approximate.

MASH is a trademark of NTT.